

# TAC Milling Inserts

## Guideline for Selection of Inserts for Milling

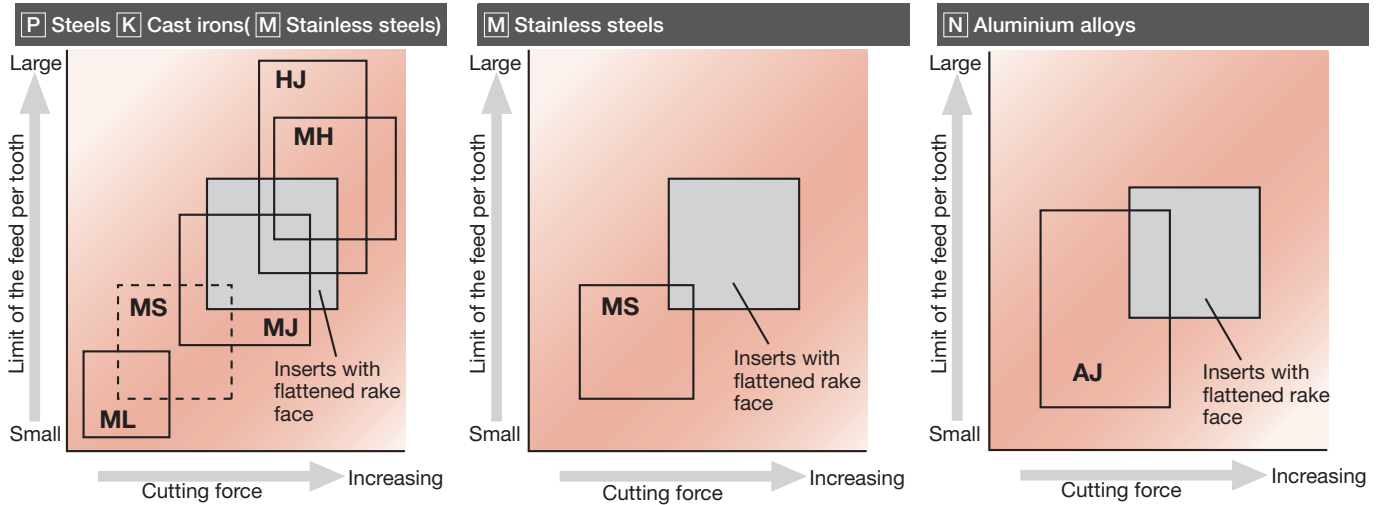

## Features of Inserts for Milling

Type	Features	Work materials	Cross sections of the cutting edge (Outline figure)
<b>MJ</b>	<ul style="list-style-type: none"> <li>The inserts have functional curvatures at cutting edges and relief faces.</li> <li>General inserts with both impact resistance and the function of cutting force reduction.</li> </ul>	<ul style="list-style-type: none"> <li><b>P</b> Steels</li> <li><b>K</b> Cast irons</li> <li>Ductile cast irons</li> <li>(<b>M</b>) Stainless steels</li> </ul>	
<b>HJ</b>	<ul style="list-style-type: none"> <li>Allows super high feeds as high as 1.5 to 2 times those of general purpose inserts.</li> <li>Even under high machining load at high feeds, ensures superior impact resistance and low cutting forces. (Maximum depth of cut: 2 mm)</li> </ul>		
<b>ML</b>	<ul style="list-style-type: none"> <li>Lowered cutting force compared with MJ type</li> <li>Applicable when chattering occurs in using MJ type.</li> </ul>		
<b>MH</b>	<ul style="list-style-type: none"> <li>Suitable for high feed milling.</li> <li>Available when chipping occurs in using MJ type.</li> <li>Toughness priority.</li> </ul>		
<b>MS</b>	<ul style="list-style-type: none"> <li>Low cutting force compared with MJ type</li> <li>For stainless steels (and mild steels)</li> <li>Applicable for burr reduction.</li> </ul>	<ul style="list-style-type: none"> <li>(<b>M</b>) Stainless steels</li> <li>(Mild steels)</li> </ul>	
<b>AJ</b>	<ul style="list-style-type: none"> <li>For non-ferrous metals such as aluminium alloys etc.</li> <li>Inserts have sharp edges and mirror like rake faces.</li> <li>Applicable for burr reduction.</li> </ul>	<ul style="list-style-type: none"> <li>(<b>N</b>) Aluminium alloys</li> <li>(Non-ferrous metals)</li> </ul>	

# TAC Milling Inserts

## Inserts

### ●ADMT□□□□08PR-MJ

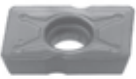
Shape	Cat. No.	Accuracy	Honing	Stocked grades										Applicable TAC mills (Page)	
				Coated											
				AH120	AH140	T3130									
	ADMT130308PR-MJ	M	With	●	●	●									ELP-A (Used for end cutting edge) <a href="#">9-121</a>
	ADMT17T308PR-MJ			●	●	●									
	ADMT210408PR-MJ			●	●	●									

### ●AECW□□□□PES/FR, AEMW□□□□PES/T/FR

Shape	Cat. No.	Accuracy	Honing	Stocked grades										Applicable TAC mills (Page)
				Coated			Cermet		Uncoated					
				AH120	GH330		NS740		TH10	UX30				
	AECW1403PESR	C	With	●	●		●			●				EPE4000 (Former products)
	AECW16T3PESR		With	●	●		●			●				EPE5000 (Former products)
	AECW1804PESR		With	●	●		●			●				EPE6000 (Former products)
	AECW1804PEFR		Without				●		●					
	AEMW1403PETR	M	With		●		●			●				EPE4000 (Former products)
	AEMW16T3PETR		With		●		●			●				EPE5000 (Former products)
	AEMW1804PETR		With		●		●			●				EPE6000 (Former products)
	AEMW1804PEFR		Without							●				



### ●AO□T0702□□PD□R-MJ/HJ/AJ

**TUNGREC**  
TUNGALOY

Shape	Cat. No.	Accuracy	Honing	Stocked grades										Applicable TAC mills (Page)
				Coated				Uncoated						
				AH725	AH140			KS15F						
 -MJ	AOMT070202PDPR-MJ	M	With	●	●									EPO07R TPO07R <a href="#">9-58</a>
	AOMT070204PDPR-MJ			●	●									
	AOMT070208PDPR-MJ			●	●									
	AOMT070216PDPR-MJ			●	●									
	AOMT070208PDPR-HJ			●	●									
	AOGT070204PDFR-AJ			G	Without				●					

● : Stocked items.

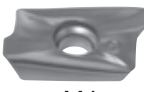
●AO□T1805□□PD□R-MJ/AJ

Shape	Cat. No.	Accuracy	Honing	Stocked grades										Applicable TAC mills (Page)	
				Coated					Uncoated						
				AH725	AH140				KS15F						
 -MJ	AOMT180508PDPR-MJ	M	With	●	●										EPO18R TPO18R ▶ 9-64
	AOMT180516PDPR-MJ			●	●										
	AOMT180524PDPR-MJ			●	●										
	AOMT180532PDPR-MJ			●	●										
 -AJ	AOGT180504PDFR-AJ	G	Without							●					
	AOGT180508PDFR-AJ										●				

●APMT120416PR-MJ

Shape	Cat. No.	Accuracy	Honing	Stocked grades										Applicable TAC mills (Page)	
				Coated											
				AH120	T3130										
	APMT120416PR-MJ	M	With	●	●										TZP12 ▶ 9-122

●APMT□□□□08PN-MJ





Shape	Cat. No.	Accuracy	Honing	Stocked grades										Applicable TAC mills (Page)	
				Coated											
				AH120	AH140	GH330	T3130								
	APMT070308PN-MJ	M	With	●	●	●	●								ELP-A ▶ 9-121 (Used for both end and peripheral edges)
	APMT09T308PN-MJ			●	●	●	●								
	APMT120408PN-MJ			●	●	●	●								

● : Stocked items.



# TAC Milling Inserts



## ●AS□T11T3□□PD□R-MJ/MS/AJ

Shape	Cat. No.	Accuracy	Honing	Stocked grades									Applicable TAC mills (Page)		
				Coated						DLC coated	Cermet	Uncoated			
				AH725	AH120	AH130	AH140	T3130	T1115	DS1100	NS740	KS05F			
 -MJ	ASMT11T304PDPR-MJ	M	With	●	●			●	●			●		EPS11 TPS11 ELS11 TLS11 	
	ASMT11T308PDPR-MJ			●	●			●	●				●		
	ASMT11T312PDPR-MJ			●	●			●							
ASMT11T316PDPR-MJ	●			●			●					●			
ASMT11T320PDPR-MJ				●											
ASMT11T330PDPR-MJ				●											
ASMT11T304PDPR-MS					●	●									
 -MS	ASMT11T304PDPR-MS	G	Without							●		●			
	ASGT11T304PDFR-AJ									●		●			
 -AJ	ASGT11T308PDFR-AJ														

## ●AS□T1705□□PD□R-MJ/MS/AJ

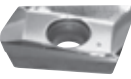
Shape	Cat. No.	Accuracy	Honing	Stocked grades									Applicable TAC mills (Page)		
				Coated						DLC coated	Cermet	Uncoated			
				AH725	AH120	AH130	AH140	T3130	T1115	DS1100	NS740	KS05F			
 -MJ	ASMT170504PDPR-MJ	M	With		●			●	●			●		EPS17 TPS17 	
	ASMT170508PDPR-MJ				●			●	●				●		
	ASMT170512PDPR-MJ				●			●							
ASMT170516PDPR-MJ				●			●					●			
ASMT170520PDPR-MJ				●											
ASMT170530PDPR-MJ				●											
ASMT170532PDPR-MJ				●				●				●			
 -MS	ASMT170508PDPR-MS	G	Without			●	●								
	ASGT170504PDFR-AJ									●		●			
 -AJ	ASGT170508PDFR-AJ											●			

● : Stocked items.

●CPMW/T□□□□08EN

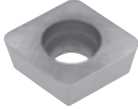
Shape	Cat. No.	Accuracy	Honing	Stocked grades								Applicable TAC mills (Page)
				Coated				Uncoated				
				GH330				UX30				
	CPMW050208EN	M	With	●				●				EVP1000 (Former products)
	CPMW06T208EN			●				●				
	CPMT080308EN			●				●				

●DCMW□□□□04TN

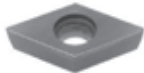
Shape	Cat. No.	Accuracy	Honing	Stocked grades								Applicable TAC mills (Page)
				Coated								
				AH120	AH330							
	DCMW070204TN	M	With	●	●							EBP <span style="color:red">▶ 9-118</span>
	DCMW11T304TN			●	●							

●DPCW11T3ZFR

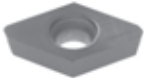
Shape	Cat. No.	Accuracy	Honing	Stocked grades								Applicable TAC mills (Page)
				Coated				Cermet				
				AH740				NS530				
	DPCW11T3ZFR	C	Without	●					●			TZF11 <span style="color:red">▶ 9-124</span>

●EDKW53ZT/FR

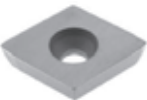
Shape	Cat. No.		Accuracy	Honing	Stocked grades								Applicable TAC mills (Page)
					Coated				Uncoated				
					GH330				UX30				
	EDKW53ZTR	EDKW1504EDTR	K	With	●					●		ESD5000 (Former products)	

●GD□T□□□□PD□R-MJ/AJ

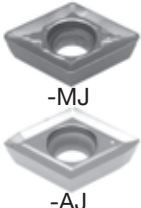
Shape	Cat. No.		Accuracy	Honing	Stocked grades								Applicable TAC mills (Page)
					Coated				DLC coated	Uncoated			
					AH120	AH140	AH330	T3130	DS1100	UX30	TH10		
	GDMT10H3PDPR-MJ		M	With	●	●	●	●			●	ESD10 <span style="color:red">▶ 9-116</span>	
	GDGT10H3PDR-AJ		G	Without					●		●		

● : Stocked items.

# TAC Milling Inserts



## ●LMEU□□□□□ZHEN-MJ

Shape	Cat. No.	Accuracy	Honing	Stocked grades										Applicable TAC mills (Page)	
				Coated											
				AH725	AH120	AH140									
 -MJ	LMEU100808ZHEN-MJ	E	With	●	●	●									ASN10R TSN10R ▶ 9-135
	LMEU100816ZHEN-MJ			●	●	●									
	LMEU100824ZHEN-MJ			●	●	●									
	LMEU100832ZHEN-MJ			●	●	●									
	LMEU120808ZHEN-MJ	E	With	●	●	●									ASN12R TSN12R ▶ 9-135
	LMEU120816ZHEN-MJ			●	●	●									
	LMEU120824ZHEN-MJ			●	●	●									
	LMEU120832ZHEN-MJ			●	●	●									
	LMEU150908ZHEN-MJ	E	With	●	●	●									ASN15R TSN15R ▶ 9-135
	LMEU150916ZHEN-MJ			●	●	●									
	LMEU150924ZHEN-MJ			●	●	●									
	LMEU150932ZHEN-MJ			●	●	●									

## ●LMMU□□□□□PNER-MJ



Shape	Cat. No.	Accuracy	Honing	Stocked grades										Applicable TAC mills (Page)	
				Coated											
				AH725	AH120	AH140	T3130	T1115							
 -MJ	LMMU110708PNER-MJ	M	With	●	●	●	●	●							EPM11 TPM11 TLM11 ▶ 9-68
	LMMU110716PNER-MJ			●	●	●	●	●							
	LMMU110724PNER-MJ			●	●	●	●	●							
	LMMU110732PNER-MJ			●	●	●	●	●							
	LMMU160908PNER-MJ			●	●	●	●	●							TPM16 ▶ 9-68
	LMMU160916PNER-MJ			●	●	●	●	●							
	LMMU160924PNER-MJ			●	●	●	●	●							
	LMMU160932PNER-MJ			●	●	●	●	●							

9

TAC Mills

● : Stocked items.





● LNMU0303ZER-MJ/ML

Shape	Cat. No.	Accuracy	Honing	Stocked grades								Applicable TAC mills (Page)
				Coated								
				AH725	AH130	AH3035 <sup>NEW</sup>						
 -MJ   -ML	LNMU0303ZER-MJ	M	With	●	●	●						EXN03  ▶ 9-93
	LNMU0303ZER-ML			●	●	●						

● LNMU06X5ZER-MJ/ML



Shape	Cat. No.	Accuracy	Honing	Stocked grades								Applicable TAC mills (Page)
				Coated								
				AH725	AH120	AH130	AH3035 <sup>NEW</sup>					
 -MJ   -ML	LNMU06X5ZER-MJ	M	With	●	●	●	●					EXN06  ▶ 9-93
	LNMU06X5ZER-ML			●	●	●	●					

● LQMU□□□□□PNER-MJ



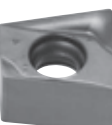

Shape	Cat. No.	Accuracy	Honing	Stocked grades								Applicable TAC mills (Page)
				Coated								
				AH725	AH120	AH140						
 -MJ	LQMU110704PNER-MJ	M	With	●	●	●						E/TPQ11 ▶ 9-57
	LQMU110708PNER-MJ			●	●	●						
	LQMU110716PNER-MJ			●	●	●						
	LQMU180804PNER-MJ			●	●	●						E/TPQ18 ▶ 9-57
	LQMU180808PNER-MJ			●	●	●						
	LQMU180816PNER-MJ			●	●	●						
	LQMU180824PNER-MJ			●	●	●						

● : Stocked items.

# TAC Milling Inserts



●ON□U□□□□AN□□-ML/MJ/W



Shape	Cat. No.	Accuracy	Honing	Stocked grades												Applicable TAC mills (Page)	
				Coated													
				AH725	AH120	AH140	T1115 <sup>NEW</sup>										
 -ML	ONHU0705ANPN-MJ	H	With	●		●											
	ONHU0705ANTN-ML			●	●	●	★										
	ONHU0705ANPR-W				●												
 -MJ	ONMU0705ANPN-MJ	M		●		●											
	ONMU0705ANPN-ML				●		★										
 -W																	
TAN07 <span style="float: right;">▶ 9-43</span>																	

●PNCU0905GN□R-MJ/W/AJ





Shape	Cat. No.	Accuracy	Honing	Stocked grades										Applicable TAC mills (Page)		
				Coated					Cermet	Uncoated						
				AH725	AH120	AH140	T3130 <sup>NEW</sup>	T1115 <sup>NEW</sup>	NS740 <sup>NEW</sup>	TH10						
 -MJ	PNCU0905GNER-MJ	C	With	●	●	●	●	●	●							
	PNCU0905GNER-W			●												
	PNCU0905GNFR-AJ		Without									●				
 -W																
 -AJ																
E/TEN09 <span style="float: right;">▶ 9-40</span>																

TAC Mills

9

●RCMT□□□□EN-NMJ/MJ, RCMT□□□□FN-NAJ



Shape	Cat. No.	Accuracy	Honing	Stocked grades								Applicable TAC mills (Page)				
				Coated				Uncoated								
				AH725	AH120	AH140	KS15F									
 -NMJ	RCMT1204EN-NMJ	M	With	●	●	●										
	RCMT1606EN-NMJ			●	●	●										
	RCMT1204EN-MJ			●	●	●										
RCMT1606EN-MJ	●		●	●												
 -MJ	RCMT1204FN-NAJ		Without				●									
	RCMT1606FN-NAJ						●									
 -NAJ																
E/TRC12, 16 <span style="float: right;">▶ 9-108</span>																

● : Stocked items  
★ : Available from 2013



●RDMW05/07/10□□M0

Shape	Cat. No.	Accuracy	Honing	Stocked grades												Applicable TAC mills (Page)		
				Coated						Uncoated								
				AH120														
	RDMW0501M0	M	With	●													HWD05 <a href="#">▶ 9-126</a>	
	RDMW0702M0			●														HWD07 <a href="#">▶ 9-126</a>
	RDMW1003M0			●														HWD10 <a href="#">▶ 9-126</a>

●RDCM1203T/FN, RDMA1203T/FN

Shape	Cat. No.	ISO Metric Cat. No.	Accuracy	Honing	Stocked grades												Applicable TAC mills (Page)
					Uncoated						Coated						
					UX30												
	RDCM1203TN	RDCM1203M0TN	C	With	●												ERD4000 (Former products)
	RDCM1203FN	RDCM1203M0FN		Without													
	RDMA1203TN	RDMA1203M0TN	M	With	●												
	RDMA1203FN	RDMA1203M0FN		Without													

●RDM□1204ZD□N(-MJ), RDM□1606ZD□N(-MJ)

Shape	Cat. No.	Accuracy	Honing	Stocked grades												Applicable TAC mills (Page)		
				Coated						Uncoated								
				AH120	AH130	AH140	AH330	T3130	UX30									
	RDMT1204ZDPN-MJ	M	With	●		●	●	●	●								TRD12 <a href="#">▶ 9-110</a>	
	RDMT1606ZDPN-MJ			●	●	●	●	●									TRD16 <a href="#">▶ 9-110</a>	
	RDMW1204ZDSN			●		●		●										TRD12 <a href="#">▶ 9-110</a>
	RDMW1606ZDSN			●		●		●										TRD16 <a href="#">▶ 9-110</a>

●RFEN2004□□T/FN

Shape	Cat. No.	Accuracy	Honing	Stocked grades												Applicable TAC mills (Page)		
				Coated						Uncoated								
				AH120	GH330					KS20	UX30							
	RFEN2004M0TN	E	With		●							●	●				TRF6000 ERF6000 <a href="#">▶ 9-112</a>	
	RFEN2004M0FN		Without															
	RFEN2004ZFTN		With	●	●								●	●				
	RFEN2004ZFFN		Without															



● : Stocked items.

# TAC Milling Inserts

## ●SCMT□□□□08-23



Shape	Cat. No.	Accuracy	Honing	Stocked grades												Applicable TAC mills (Page)
				Coated												
				AH120												
	SCMT09T308-23	M	With	●												EBD <span style="background-color: #f08080; padding: 2px;">▶ 9-119</span>
	SCMT120408-23			●												

## ●SD□N1203AETN, SDCN1203AEFN-D, SD□R1203AETN-MJ, SDKR1203AE□□-M□

Shape	Cat. No.	ISO Metric Cat. No.	Accuracy	Honing	Stocked grades												Applicable TAC mills (Page)
					Coated							Cermet		Uncoated	T-DIA		
					AH120	AH130	AH140	AH330	GH330	T3130	T1115	NS740	N308	TH10	UX30	DX140	
	SDKN42ZTN	SDKN1203AETN-12	K	With	●	●	●	●	●	●	●	●	●			TMD440I TGD4400-A TFD4400-A EMD4403 RI-S32 EGD4400 (Former products)	
	SDKN42ZFN	SDKN1203AEFN-12		Without													
	SDKN42ZTNCR	SDKN1203AETN-CR		With						●							
	SDKN42ZTN16	SDKN1203AETN-16		Without						●							
 - MJ	SDCN42ZFN-DIA	SDCN1203AEFN-D	C	Without									●				
	SDMR1203AETN-MJ		M	With						●							
	SDKR42ZPN-MS	SDKR1203AEPN-MS	K	With			●										
	SDKR42ZSR-MJ	SDKR1203AESR-MJ	K	With	●		●	●	●								



"DX140" : Packing quantity=1 pcs

## ●SD□N53Z□N□, SDKR53ZSR-MJ



Shape	Cat. No.	ISO Metric Cat. No.	Accuracy	Honing	Stocked grades												Applicable TAC mills (Page)
					Coated					Cermet		Uncoated					
					AH120	AH130	AH140	GH330	T3130	NS740	N308	TH10	UX30				
	SDCN53ZTN	SDCN1504AETN	C	With						●	●				TMD5400RIE <span style="background-color: #f08080; padding: 2px;">▶ 9-50</span>		
	SDCN53ZFN	SDCN1504AEFN		Without													
	SDEN53ZTN	SDEN1504AETN	E	With			●			●	▲		●				
	SDEN53ZFN	SDEN1504AEFN		Without								●					
 - MJ	SDKN53ZTN	SDKN1504AETN	K	With	●	●	●	●		●	●		●				
	SDKN53ZFN	SDKN1504AEFN		Without								●					
	SDEN53ZTN20	SDEN1504AETN-20	E	With					●								
	SDKN53ZTN16	SDKN1504AETN-16	K							●							
	SDEN53ZTNCR	SDEN1504AETNCR	E								●						
	SDKN53ZTNCR	SDKN1504AETNCR	K								●						
SDKR53ZSR-MJ	SDKR1504AESR-MJ	K				●	●										

● : Stocked items.  
▲ : Shortly unavailable



●SDMT050204PN-MJ, SDHT050204FN-AJ

Shape	Cat. No.	Accuracy	Honing	Stocked grades										Applicable TAC mills (Page)		
				Coated					Uncoated							
				AH725	AH140				TH10							
 -MJ  -AJ	SDMT050204PN-MJ	M	With	●	●											TPD05 EPD05 ELD05 
	SDHT050204FN-AJ	H	Without				●									

●SD□T1204AF□N-□□

Shape	Cat. No.	Accuracy	Honing	Stocked grades										Applicable TAC mills (Page)	
				Coated					Cermets		Uncoated				
				AH120	AH140	AH330	GH330	T3130	NS740	NS530		TH10			
 -MJ  -AJ	SDMT1204AFPN-MJ	M	With	●	●	●	●	●							TAD12 (Former products)
	SDMT1204AFTN-MJ							●	●						
	SDMT1204AFPN-ML			●	●										
	SDMT1204AFPN-MS		●												
	SDGT1204AFTN-MJ	G	Without	●	●			●	●						
	SDGT1204AFFN-AJ									●					







●SD□T1204PD□R-□□

Shape	Cat. No.	Accuracy	Honing	Stocked grades										Applicable TAC mills (Page)
				Coated					Cermets		Uncoated			
				AH120	AH140	AH330	GH330	T3130	NS740	NS530		TH10		
 -MJ  -AJ	SDMT1204PDSR-MJ	M	With	●	●	●	●	●						TPD12 (Former products)
	SDMT1204PDTR-MJ							●	●					
	SDMT1204PDPR-ML			●	●									
	SDMT1204PDPR-MS		●											
	SDGT1204PDTR-MJ	G	Without	●	●			●	●					
	SDGT1204PDFR-AJ									●				

● : Stocked items.

# TAC Milling Inserts

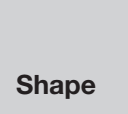
## ●SE□N1203AG□□, SEKR1203AGSR-MJ

Shape	Cat. No.	Accuracy	Honing	Stocked grades										Applicable TAC mills (Page)		
				Coated							Cermet	Uncoated				
				AH120	AH130	AH140	AH330	GH330	T3130	T1115	NS740	TH10	UX30			
   -MJ   -MS  	SECN1203AGTN	C	With													TME4400I TME4400B 9-49
	SECN1203AGFN		Without											●		
	SEEN1203AGTN	E	With	●	●	●		●		●		●		●		
	SEEN1203AGFN		Without										●			
	SEEN1203AGTNCR	E	With	●	●	●	●		●							
	SEEN1203AGTNCR-14		Without													
	SEKN1203AGTN	K	With	●	●	●	●	●				●		●		
	SEKN1203AGFN		Without													
	SEKN1203AGTNCR	E	With										●			
	SEEN1203AGTN-T		Without											●		
	SEEN1203AGFN-T	K	With					●	●	●		●		●		
	SEKN1203AGTN-T		Without											●		
	SEKR1203AGSR-MJ	K	With	●			●	●	●							
	SEKR1203AGPN-MS		Without													

## ●SN□N43ZT/FN, SNKF43ZT/FN

Shape	Cat. No.	ISO Metric Cat. No.	Accuracy	Honing	Stocked grades								Applicable TAC mills (Page)	
					Coated		Cermet		Uncoated		Ceramics			
					T3130	T1115	NS740	N308	TH10	UX30	FX105	CX710		
	SNCN43ZTN	SNCN1204ZNTN	C	With			●	●		●				TGN4200-A 9-53
	SNCN43ZFN	SNCN1204ZNFN		Without						●				
	SNKN43ZTN	SNKN1204ZNTN	K	With	●	●	●			●		●		
	SNKN43ZFN	SNKN1204ZNFN		Without										
	SNKF43ZTN	SNKF1204ZNTN		With		●					●			
	SNKF43ZFN	SNKF1204ZNFN		Without							●			

## ●SNA□56FTR/L, SNC□56FTR/L

Shape	Cat. No.	ISO Metric Cat. No.	Accuracy	Honing	Stocked grades										Applicable TAC mills (Page)	
					Cermet											
					X407											
	SNA56FTR	SNAC1509PNTR	A	With	●											MS cutter (Former products)
	SNAG56FTR	SNAJ1509PNTR														

Packing Quantity=4 pcs.

● : Stocked items.

●SNEN12T2Z□N, SNEN1233Z□N

Shape	Cat. No.	Accuracy	Honing	Stocked grades												Applicable TAC mills (Page)
				Uncoated												
				UX30	TH10											
	SNEN12T2ZTN	E	With	●												SVN4000 ▶ 9-137
	SNEN12T2ZFN		Without		●											
	SNEN1233ZTN		With	●												
	SNEN1233ZFN		Without		●											

●SNMN□□□□

Shape	Cat. No.	Accuracy	Honing	Stocked grades												Applicable TAC mills (Page)
				Coated				Uncoated		Caramics						
				AH120	T3130	T1115	UX30			FX105	CX710					
	SNMN120408TN	M	With							●						TGN4200-A ▶ 9-53
	SNMN120412TN			●	●	●	●			●						
	SNMN120416TN									●						
	SNMN120420TN									●						
	SNMN120424TN									●						
	SNMN190412TN									▲						
	SNMN190416TN									●						

●SNMU1706AN□R-ML/MJ, SNHU1706AN□□-MJ/W



Shape	Cat. No.	Accuracy	Honing	Stocked grades												Applicable TAC mills (Page)
				Coated												
				AH725	AH120	AH140	T1115									
	SNHU1708ANPR-MJ	H	With	●		●										TAN07 ▶ 9-43
	SNHU1708ANTR-ML		Without		●		★									
	SNHU1708ANFN-W	M	Without		●											
	SNMU1708ANPR-MJ		With	●		●										
	SNMU1708ANTR-ML		With		●		★									

● : Stocked items  
 ▲ : Shortly unavailable  
 ★ : Available from 2013

# TAC Milling Inserts

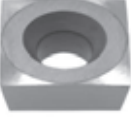

## ●SPHA431FNW, SPHA435FNW

Shape	Cat. No.	ISO Metric Cat. No.	Accuracy	Honing	Stocked grades										Applicable TAC mills (Page)			
					Cermet					Uncoated								
					N308	TH10												
	SPHA435FNW	SPHB120420FN-W	H	Without	●	●												TFD4400-A (Former products) TFP4000IA (Former products) SFP4000 ▶ 9-130





## ●SPMP831DS, SPMP/M□□2ERD

Shape	Cat. No.	ISO Metric Cat. No.	Accuracy	Honing	Stocked grades										Applicable TAC mills (Page)				
					Coated														
					T313W														
	SPMP831DS	SPMT060204-DS	M	With	●													TCB ▶ 9-129	
	SPMP042ERD	SPMP080308ER-D			●														
	SPMM322ERD	SPMT090308ER-D			●														
	SPMM432ERD	SPMT120408ER-D			●														

## ●SPMR1605PP□R-M□

Shape	Cat. No.	Accuracy	Honing	Stocked grades										Applicable TAC mills (Page)				
				Coated					Uncoated									
				GH330	T3130	T1115			UX30									
 -MJ	SPMR1605PPTR-MJ	M	With	●	●	●				●							TPP16RIE ▶ 9-82	
	SPMR1605PPTR-MH			●	●				●									
	SPMR1605PPPR-ML			●														
 -MH																		
 -ML																		

●SP□□1203

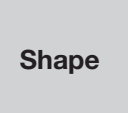
Shape	Cat. No.	ISO Metric Cat. No.	Accuracy	Honing	Stocked grades										Applicable TAC mills (Page)	
					Coated					Cermet		Uncoated		Ceramics		
					AH120	AH140	GH330	T3130	T1115	NS740	N308	TH10	UX30	FX105		CX710
	SPEN423TN	SPEN120312TN	E	With				●			●			●		
	SPEN423FN	SPEN120312FN		Without									●			
	SPCN42STR	SPCN1203EDTR	C	With							●	●		●		
	SPCN42STL	SPCN1203EDTL		Without									●			
	SPEN42STR	SPEN1203EDTR	E	With							●					
	SPEN42STL	SPEN1203EDTL		Without												
	SPKN42STR	SPKN1203EDTR	E	With	●	●	●	●	●		●	●		●	●	
	SPKN42STL	SPKN1203EDTL		Without							●			●		
	SPGN120312TN		G	With												●
	SPKR42SSR-MJ	SPKR1203EDSR-MJ	K	With			●	●	●							

TGP 4100RBAE  
▶ 9-51

**DOFEEDQUAD**  
TUNGALOY

●SQMU1203ZSR-MJ

Shape	Cat. No.	Accuracy	Honing	Stocked grades										Applicable TAC mills (Page)		
				Coated												
				AH725	AH120	AH130	T3130									
	SQMU1206ZSR-MJ	M	With	●	●	●	●									
																TXQ12 ▶ 9-99









9  
TAC Mills

● : Stocked items.

# TAC Milling Inserts

●SW□□13T3AF□R-□□



Shape	Cat. No.	Accuracy	Honing	Stocked grades										Applicable TAC mills (Page)			
				Coated					DLC coated	Cermet	Uncoated						
				AH120	AH130	AH140	T3130	T1115		GH110	DS1100	NS740	KS05F				
 -MJ	SWMT13T3AFPR-MJ	M	With	●	●	●	●	●					●		TAW13 		
	SWMT13T3AFER-ML			●													
 -ML	SWMW13T3AFTR			●			●	●								●	
	SWMT13T3AFPR-HJ			●	●	●	●	●									
	SWMT13T3AFPR-MS				●	●											
 -FL	SWGT13T3AFFR-AJ			G	Without								●			●	
	SWGT13T3AFPR-MJ	With	●										●				
 -HJ																	
 -MS																	
 -AJ																	
 SWGT-MJ																	

TAC Mills





9

● : Stocked items.



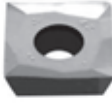

●SW□□1304PD□R-□□

Shape	Cat. No.	Accuracy	Honing	Stocked grades									Applicable TAC mills (Page)		
				Coated					DLC coated	Cermet	Uncoated	T-DIA			
				AH120	AH130	AH140	T3130	T1115	DS1100	NS740	KS05F				
 -MJ	SWMT1304PDPR-MJ	M	With	●	●	●	●	●				●			
	SWMT1304PDER-ML			●											
	SWMT1304PDPR-MS				●	●									
 -ML	SWGT1304PDFR-AJ	G	Without							●		●			
	SWGT1304PDPR-MJ		With	●								●			
 -MS															
 -AJ															
 SWGT-MJ															

▶ 9-72



TPW13



9

TAC Mills

●TECN32Z□□, TEEN32Z□□, TECN32ZFR-DIA, TEKR1603PEPR-MS

Shape	Cat. No.	ISO Metric Cat. No.	Accuracy	Honing	Stocked grades										Applicable TAC mills (Page)	
					Coated							Cermet	Uncoated	T-DIA		
					AH120	AH130	AH140	AH330	GH330	T3130	T1115	NS740	N308	TH10		UX30
	TECN32ZTR	TECN1603PETR	C	With								●	●		●	
	TECN32ZTL	TECN1603PETL														
	TECN32ZFR	TECN1603PEFR		Without										●		
 -DIA	TECN32ZFL	TECN1603PEFL	E	With	●	●	●	●	●	●	●	●	●		●	
	TEEN32ZTR	TEEN1603PETR														
	TEEN32ZTL	TEEN1603PETL														
	TEEN32ZFR	TEEN1603PEFR		Without										●		
 -MS	TEEN32ZFL	TEEN1603PEFL	C	With												●
	TECN32ZFR-DIA	TECN1603PEFR-D														
	TEKR1603PEPR-MS		K	With			●									

▶ 9-84

TSE 3000R(IA)E

"DX140": Packing Quantity=1 pcs.

● : Stocked items.

# TAC Milling Inserts

## ●TE□N43Z□□, TECN43ZFR-DIA, TEKR2204PEPR-MS

Shape	Cat. No.	ISO Metric Cat. No.	Accuracy	Honing	Stocked grades										Applicable TAC mills (Page)			
					Coated						Cermet		Uncoated			T-DIA		
					AH120	AH130	AH140	AH330	GH330	T3130	T1115	NS740	N308	TH10		UX30	DX140	DX160
 -DIA -MS	TECN43ZTR	TECN2204PETR	C	With								●	●		●			
	TECN43ZTL	TECN2204PETL																
	TECN43ZFR	TECN2204PEFR		Without														
	TECN43ZFL	TECN2204PEFL																
	TEEN43ZTR	TEEN2204PETR		E	With	●	●	●	●	●	●	●		●	●		●	
	TEEN43ZTL	TEEN2204PETL																
	TEEN43ZFR	TEEN2204PEFR		Without														
	TEEN43ZFL	TEEN2204PEFL																
	TECN43ZFR-DIA	TECN2204PEFR-D		C	Without												●	▲
	TEKR2204PEPR-MS			K	With		●											

“DX140”: Packing Quantity=1 pcs.

## ●WDCN42ZFR-DIA

Shape	Cat. No.	ISO Metric Cat. No.	Accuracy	Honing	Stocked grades							Applicable TAC mills (Page)
					T-DIA							
					DX140							
 Wiper inserts	WDCN42ZFR-DIA	SDCX1203AEFR-WD	C	Without	●							

“DX140” : Packing Quantity=1 pcs.

## ●SPAX1203EDFR-W



Shape	Cat. No.	ISO Metric Cat. No.	Accuracy	Honing	Stocked grades						Applicable TAC mills (Page)	
					Cermet			Uncoated				
					N308			TH10				
 Wiper inserts (Two corner type)	WPAN42SFR	SPAX1203EDFR-W	A	Without	●				●			

● : Stocked items.





# TAC Milling Inserts

## ●XCET310404ER

Shape	Cat. No.	Accuracy	Honing	Stocked grades										Applicable TAC mills (Page)			
				Coated		Cermet		Uncoated									
				AH330		NS740	NS530	UX30									
	XCET310404ER	E	With	●		●	●	●									ECC31
 9-127																	



## ●XHGR□□□□□ER-MJ

**HYBRID TAC MILL**  
TUNGALOY

Shape	Cat. No.	Accuracy	Honing	Stocked grades										Applicable TAC mills (Page)				
				Coated		Uncoated												
				AH730														
 -MJ	XHGR110202ER-MJ	G	With	●													EPH11, 13, 18	
	XHGR110204ER-MJ			●														
	XHGR110205ER-MJ			●														
	XHGR110208ER-MJ			●														
	XHGR110210ER-MJ			●														
	XHGR110212ER-MJ			●														
	XHGR110215ER-MJ			●														
	XHGR110216ER-MJ			●														
	XHGR110220ER-MJ			●														
	XHGR130202ER-MJ			●														
	XHGR130204ER-MJ			●														
	XHGR130205ER-MJ			●														
	XHGR130208ER-MJ			●														
	XHGR130210ER-MJ			●														
	XHGR130212ER-MJ			●														
	XHGR130215ER-MJ			●														
	XHGR130216ER-MJ			●														
	XHGR130220ER-MJ			●														
	XHGR18T202ER-MJ			●														
	XHGR18T204ER-MJ			●														
	XHGR18T205ER-MJ			●														
	XHGR18T208ER-MJ			●														
	XHGR18T210ER-MJ			●														
	XHGR18T212ER-MJ			●														
XHGR18T215ER-MJ	●																	
XHGR18T216ER-MJ	●																	
XHGR18T220ER-MJ	●																	
 9-75																		

● : Stocked items.

●XHGR□□□□□FR-AJ

Shape	Cat. No.	Accuracy	Honing	Stocked grades												Applicable TAC mills (Page)			
				DLC coated															
				DS1200															
 -AJ	XHGR110200FR-AJ	G	Without	●													EPH11, 13, 18 		
	XHGR110202FR-AJ			●															
	XHGR110204FR-AJ			●															
	XHGR110205FR-AJ			●															
	XHGR110208FR-AJ			●															
	XHGR110210FR-AJ			●															
	XHGR110212FR-AJ			●															
	XHGR110215FR-AJ			●															
	XHGR110216FR-AJ			●															
	XHGR110220FR-AJ			●															
	XHGR130200FR-AJ			●															
	XHGR130202FR-AJ			●															
	XHGR130204FR-AJ			●															
	XHGR130205FR-AJ			●															
	XHGR130208FR-AJ			●															
	XHGR130210FR-AJ			●															
	XHGR130212FR-AJ			●															
	XHGR130215FR-AJ			●															
	XHGR130216FR-AJ			●															
	XHGR130220FR-AJ			●															
	XHGR18T200FR-AJ			●															
	XHGR18T202FR-AJ			●															
	XHGR18T204FR-AJ			●															
	XHGR18T205FR-AJ			●															
	XHGR18T208FR-AJ			●															
	XHGR18T210FR-AJ			●															
	XHGR18T212FR-AJ			●															
	XHGR18T215FR-AJ			●															
	XHGR18T216FR-AJ			●															
	XHGR18T220FR-AJ			●															

● : Stocked items.

# TAC Milling Inserts

●XVGT□□□□□EC-MJ, XVGT□□□□□EP-MJ,  
XVGT□□□□□FC-AJ, XVGT□□□□□FP-AJ

**HYBRIDTACMILL**  
TUNGALOY

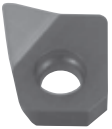
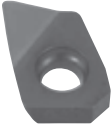
Shape	Cat. No.	Accuracy	Honing	Stocked grades										Applicable TAC mills (Page)		
				Coated					DLC coated							
				AH730					DS1200							
Center edge insert 	XVGT06H205EC-MJ	G	With	●											EVH ▶ 9-78	
	XVGT07X305EC-MJ			●												
	XVGT09X405EC-MJ			●												
	XVGT06H205EP-MJ			●												
	XVGT07X305EP-MJ			●												
	XVGT09X405EP-MJ			●												
Peripheral edge insert 	XVGT06H205FC-AJ		Without								●					
	XVGT07X305FC-AJ										●					
	XVGT09X405FC-AJ										●					
	XVGT06H205FP-AJ										●					
	XVGT07X305FP-AJ										●					
	XVGT09X405FP-AJ										●					

9

TAC Mills

●XXGT□□□□□EC-MJ, XXGT□□□□□-MJ,  
XXGT□□□□□FC-AJ, XXGT□□□□□-AJ

**HYBRIDTACMILL**  
TUNGALOY

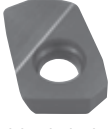

Shape	Cat. No.	Accuracy	Honing	Stocked grades										Applicable TAC mills (Page)		
				Coated					DLC coated							
				AH730					DS1200							
Center edge insert 	XXGT06H205EC-MJ	G	With	●											EXH ▶ 9-100	
	XXGT07X305EC-MJ			●												
	XXGT09X408EC-MJ			●												
	XXGT06H205EP-MJ			●												
	XXGT07X305EP-MJ			●												
	XXGT09X408EP-MJ			●												
Peripheral edge insert 	XXGT06H205FC-AJ		Without								●					
	XXGT07X305FC-AJ										●					
	XXGT09X408FC-AJ										●					
	XXGT06H205FP-AJ										●					
	XXGT07X305FP-AJ										●					
	XXGT09X408FP-AJ										●					

● : Stocked items.

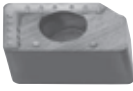
●XXMU□□□□□PR-MJ



Shape	Cat. No.	Accuracy	Honing	Stocked grades												Applicable TAC mills (Page)				
				Coated																
				AH120	AH140															
	XXMU08T204PR-MJ	M	With	●	●															
	XXMU10H308PR-MJ			●	●															
	XXMU12X408PR-MJ			●	●															
	XXMU16X508PR-MJ			●	●															
EVX <span style="border: 1px solid black; padding: 2px;">▶ 9-114</span>																				

●YDEN1505ADFR/L-D/WD

Shape	Cat. No.	Accuracy	Honing	Stocked grades												Applicable TAC mills (Page)		
				T-DIA														
				DX140														
 General inserts	YDEN1505ADFR-D	E	Without	●														
	YDEN1505ADFR-WD			●														
 Wiper inserts																		
DAD15 <span style="border: 1px solid black; padding: 2px;">▶ 9-54</span>																		

“DX140”: Packing Quantity = 1 pcs.

●YDEN1505PDFR/L-D/WD

Shape	Cat. No.	Accuracy	Honing	Stocked grades												Applicable TAC mills (Page)		
				T-DIA														
				DX140														
 General inserts	YDEN1505PDFR-D	E	Without	●														
	YDEN1505PDFR-WD			●														
 Wiper inserts																		
DPD15 <span style="border: 1px solid black; padding: 2px;">▶ 9-80</span> EDPD15																		

“DX140”: Packing Quantity = 1 pcs.

●YPEN1505PPTR/L-Q

Shape	Cat. No.	Accuracy	Honing	Stocked grades												Applicable TAC mills (Page)		
				T-CBN														
				BX950														
	YPEN1505PPTR-Q	E	With	●														
QPP15 <span style="border: 1px solid black; padding: 2px;">▶ 9-132</span>																		

“BX950”: Packing Quantity = 1 pcs.

● : Stocked items.

# TAC Milling Inserts

## ●ZD□A□□□□T/FN

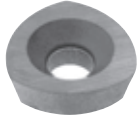
Shape	Cat. No.	Accuracy	Honing	Stocked grades												Applicable TAC mills (Page)
				Uncoated												
				UX30												
	ZDKA0704TN	K	With												TBF1000 (Former products)	
	ZDKA1105TN			▲												
	ZDCA0804TN	C		●												
	ZDCA1105TN			●												

## ●ZDMT□□□□-MJ

Shape	Cat. No.	Accuracy	Honing	Stocked grades												Applicable TAC mills (Page)
				Coated												
				AH120												
	ZDMT4005-MJ	M	With	●											EBD040 <a href="#">▶ 9-119</a>	
	ZDMT5006-MJ			●											EBD050 <a href="#">▶ 9-119</a>	

## ●ZNCA□□□□FN, ZNMM□□□□EN

Shape	Cat. No.	Accuracy	Honing	Stocked grades												Applicable TAC mills (Page)
				Uncoated												
				TH10	UX30											
	ZNCA1002FN2	C	Without	●	●										TBN1000 <a href="#">▶ 9-120</a>	
	ZNCA1203FN			●	●											
	ZNCA1603FN			●	●											
	ZNCA2004FN			●	●											
	ZNCA2505FN			●	●											
	ZNCA3005FN			●	●											
	ZNMM2004EN	M		With		●										
	ZNMM2505EN					●										
	ZNMM3005EN					●										

## ●ZPET□□□□-MJ

Shape	Cat. No.	Accuracy	Honing	Stocked grades												Applicable TAC mills (Page)
				Coated												
				AH120	AH330											
	ZPET2004-MJ	E	With	●	●										EBP020 <a href="#">▶ 9-118</a>	
	ZPET2505-MJ			●	●										EBP025 <a href="#">▶ 9-118</a>	
	ZPET3006-MJ			●	●										EBP030 <a href="#">▶ 9-118</a>	

"ZPET3006-MJ": Packing Quantity = 5 pcs.

● : Stocked items.  
▲ : Shortly unavailable